

TO CREATE CUSTOM BIG FOOT FRAMEWORKS
CALL RECTORSEAL @ 800-231-3345.

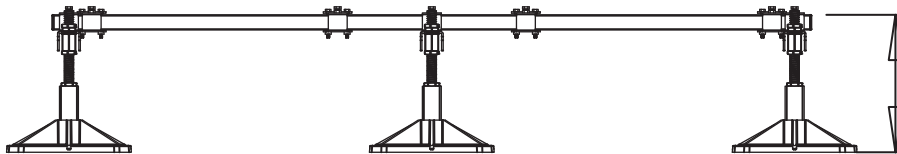

MAX: 15.6" (395mm)
MIN: 11.4" (290mm)

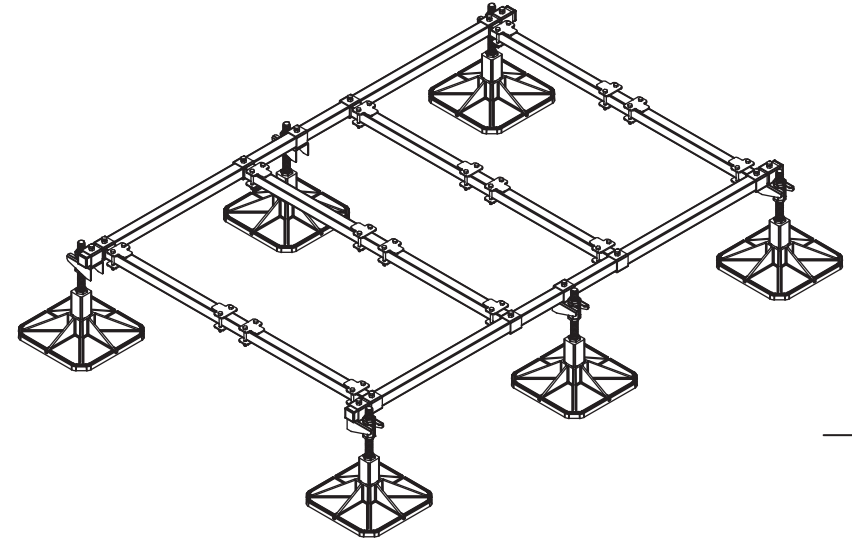

NOTE: FOR CONDENSERS HIGHER THAN 60" PLEASE CONTACT RECTORSEAL

- FEET SHOWN IN STANDARD POSITION, ON OUTSIDE OF END BARS.
- CLAMPS & CROSS BARS SHOWN ASSEMBLED CORRECTLY & IN APPROX. POSITION.

DIMENSIONS ARE IN INCHES & MILLIMETERS SURFACE FINISH: TOLERANCES: LINEAR: ANGULAR:			DEBUR AND BREAK SHARP EDGES		RECTORSEAL	
DRAWN CHK'D	NAME CB	DATE 05/16/13	MATERIAL: FINISH:	DWG NO. RES48100	A1	REVISION
			SCALE: NTS	SHEET 1 OF 1	DO NOT SCALE DRAWING	A